

CODICE	MATERIALE / FINITURA	
SCHG05082	ottone	50

CHIAVE GREZZA PER SERRATURE A LAMELLE

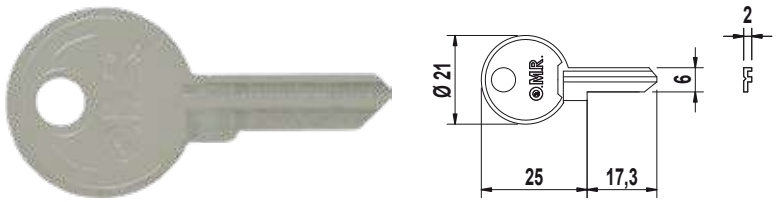

CODICE	MATERIALE / FINITURA	
SCHG05122	ottone	50

CHIAVE GREZZA PER VALVOLE GAS

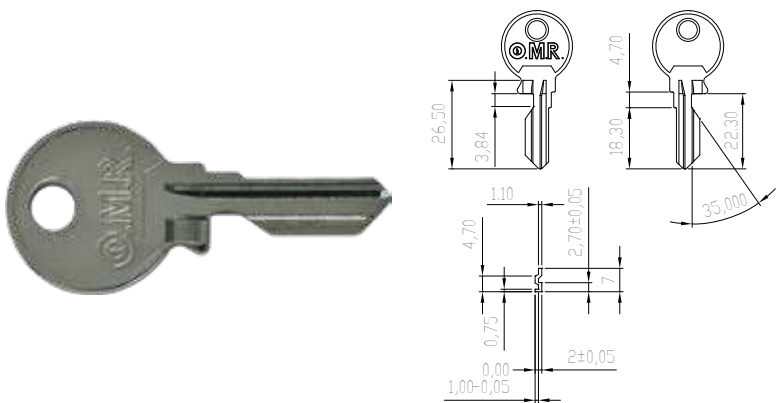

CODICE	MATERIALE / FINITURA	
SCHG05005	ottone	50

CHIAVE GREZZA PER "BUCHE LETTERE"

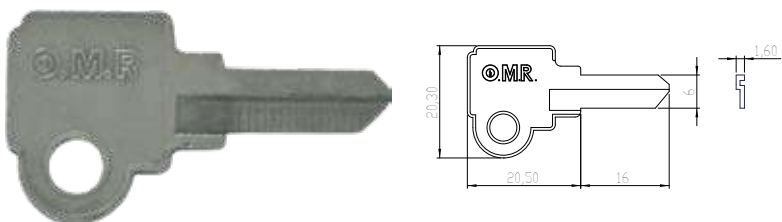

CODICE	MATERIALE / FINITURA	
SCHG05060	ottone	50

CHIAVE GREZZA

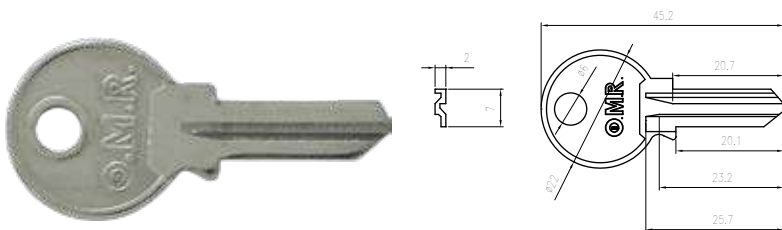

CHIAVI

CODICE	MATERIALE / FINITURA	
SCHG05070	ottone	50

CHIAVE

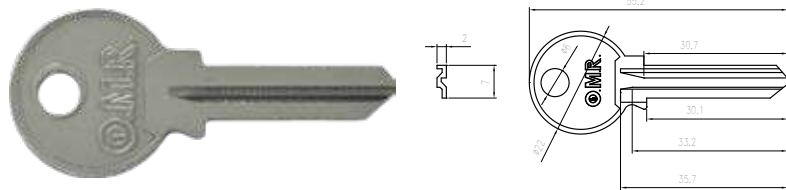

CODICE	MATERIALE / FINITURA	
SCHG05223	ottone	50

CHIAVE

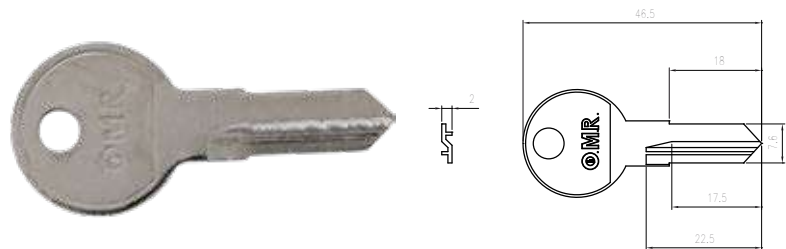

CODICE	MATERIALE / FINITURA	
ricambio g	ottone	50

CHIAVE

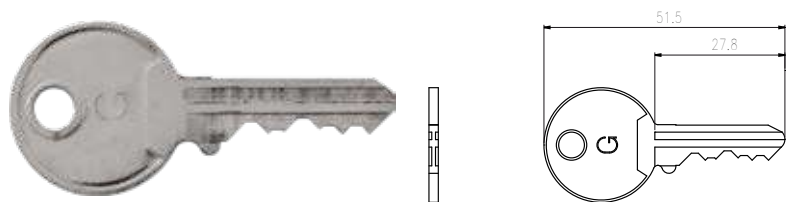

CODICE	MATERIALE / FINITURA	
MCHGYSP	ottone	50

CHIAVE

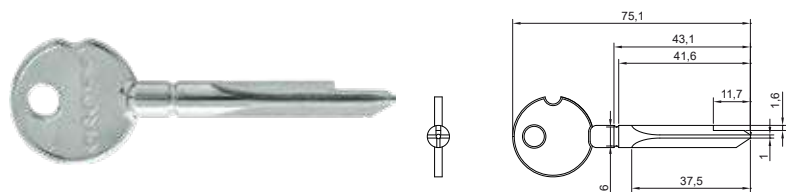

CODICE	MATERIALE / FINITURA	
MCHGYSP-L	ottone	50

CHIAVE

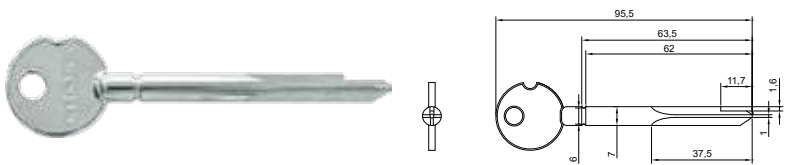

CODICE	MATERIALE / FINITURA	
Per il ricambio utilizzare articolo SCHG05082		

CHIAVE



CODICE	MATERIALE / FINITURA	
SCHG05105	plastica - ottone	50

CHIAVE

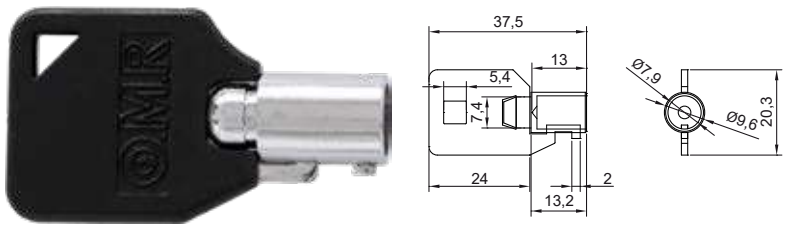

CODICE	MATERIALE / FINITURA	
SCHD05720	plastica - metallopressofuso	1

CHIAVE JACK

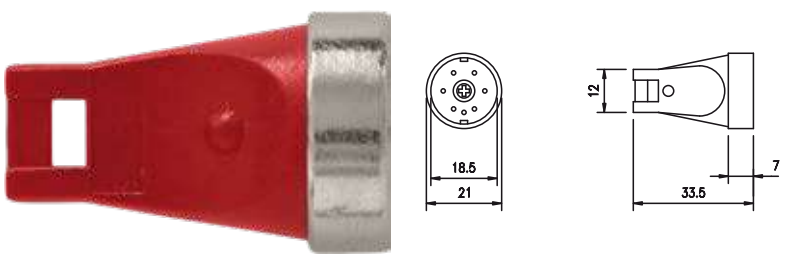

CODICE	MATERIALE / FINITURA	IMP.	
SCHD04454	plastica/nera	T5	10
SCHD04455	plastica/nera	Q7	10

CHIAVE IN PLASTICA A IMPRONTA COLLO D13

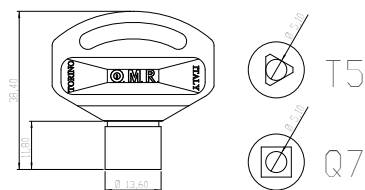

CODICE	MATERIALE / FINITURA	IMP.	
SCHD04722	plastica/nera	T5	10
SCHD04723	plastica/nera	Q7	10

CHIAVE IN PLASTICA A IMPRONTA COLLO D11

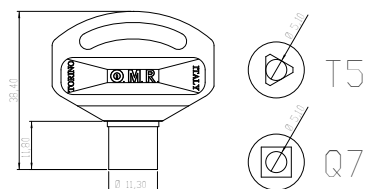

CODICE	MATERIALE / FINITURA	IMP.	
SCHD05755	metallo pressofuso	50	

CHIAVE A "IMPRONTA FIAT"

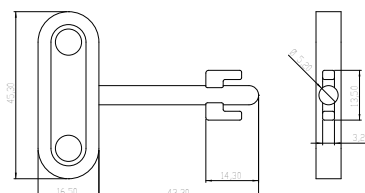

CODICE	MATERIALE / FINITURA	IMP.	
SCHD05745	metallo pressofuso	P3	10
SCHD05740	metallo pressofuso	P5	10
SCHD05750	metallo pressofuso	T6	10
SCHD05770	metallo pressofuso	Q7	10

CHIAVE A IMPRONTA - TESTA A MARTELLO

